

USEPA 1, 2 PhosVer 3[®] (Ascorbic Acid) Method 3**Method 8048****0.02 to 3.00 mg/L PO₄³⁻****Powder Pillows or AccuVac[®] Ampuls****Scope and application:** For drinking water, wastewater and seawater.

- ¹ USEPA Accepted for reporting for wastewater analyses. Procedure is equivalent to USEPA and Standard Method 4500-P-E for wastewater.
- ² USEPA Accepted for reporting for drinking water analysis. Procedure is an acceptable version of EPA Method 365.1, approved at 40 CFR part 141 NPDWR compliance monitoring.
- ³ Adapted from Standard Methods for the Examination of Water and Wastewater.



Test preparation

Before starting

Always do tests in sample cells or AccuVac[®] Ampuls. Do not put the instrument in the sample or pour the sample into the cell holder.

Make sure that the sample cells are clean and there are no scratches where the light passes through them.

Rinse the sample cell and cap with the sample three times before the sample cell is filled.

Make sure that there are no fingerprints or liquid on the external surface of the sample cells or AccuVac[®] Ampuls. Wipe with a lint-free cloth before measurement.

Cold waters can cause condensation on the sample cell or bubbles in the sample cell during color development. Examine the sample cell for condensation or bubbles. Remove condensation with a lint-free cloth. Invert the sample cell to remove bubbles.

Install the instrument cap over the cell holder before ZERO or READ is pushed.

After the test, immediately empty and rinse the sample cell. Rinse the sample cell and cap three times with deionized water.

For the best results, measure the reagent blank value for each new lot of reagent. Replace the sample with deionized water in the test procedure to determine the reagent blank value. Subtract the reagent blank value from the sample results.

Review the Safety Data Sheets (MSDS/SDS) for the chemicals that are used. Use the recommended personal protective equipment.

Dispose of reacted solutions according to local, state and federal regulations. Refer to the Safety Data Sheets for disposal information for unused reagents. Refer to the environmental, health and safety staff for your facility and/or local regulatory agencies for further disposal information.

Items to collect

Powder pillows

Description	Quantity
PhosVer [®] 3 Phosphate Reagent Powder Pillow, 10-mL	1
Sample cells, 25-mm (10 mL)	2

Refer to [Consumables and replacement items](#) on page 6 for order information.

AccuVac Ampuls

Description	Quantity
PhosVer [®] 3 Phosphate Reagent AccuVac [®] Ampul	1
Beaker, 50-mL	1

AccuVac Ampuls (continued)

Description	Quantity
Stopper for 18-mm tubes and AccuVac Ampuls	1
Sample cell, 25-mm (10 mL)	1

Refer to [Consumables and replacement items](#) on page 6 for order information.

Sample collection and storage

- Collect samples in clean glass or plastic bottles that have been cleaned with 6 N (1:1) hydrochloric acid and rinsed with deionized water.
- Do not use a detergent that contains phosphate to clean the sample bottles. The phosphate in the detergent will contaminate the sample.
- Analyze the samples as soon as possible for best results.
- If immediate analysis is not possible, immediately filter and keep the samples at or below 6 °C (43 °F) for a maximum of 48 hours.
- Let the sample temperature increase to room temperature before analysis.

Powder pillow procedure

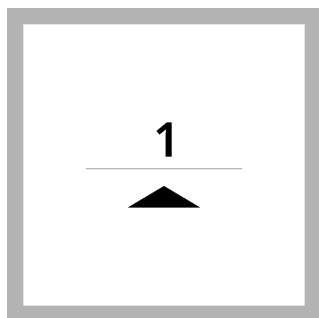

1. Set the instrument to channel 1.
For DR300, push the up arrow button. For PCII, push the menu button, checkmark button, then the menu button again.

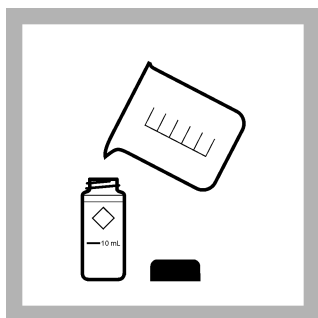

2. Prepare the sample:
Rinse a sample cell and cap three times with sample. Fill the sample cell to the 10-mL mark with sample.

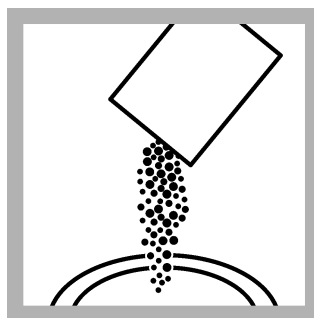

3. Add the contents of one PhosVer 3 Phosphate Reagent Powder Pillow to the sample cell. A blue color will show if phosphorus is in the sample.

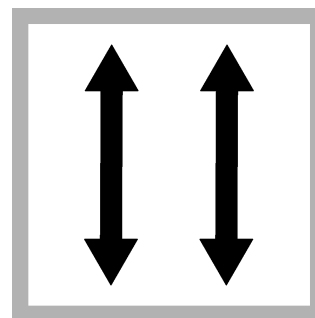

4. Put the stopper on the sample cell. Shake vigorously for 10–15 seconds.



5. Set and start a timer for 2 minutes. A 2-minute reaction time starts.

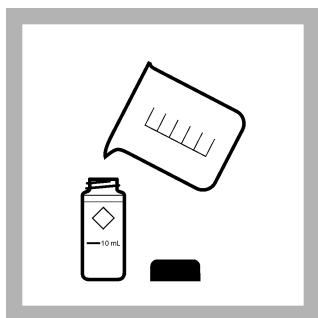

6. Prepare the blank:
Rinse a sample cell and cap three times with sample. Fill the sample cell to the 10-mL mark with sample. Close the sample cell.

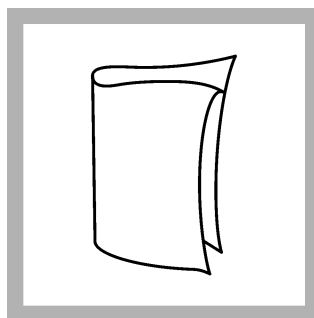

7. Clean the blank sample cell.

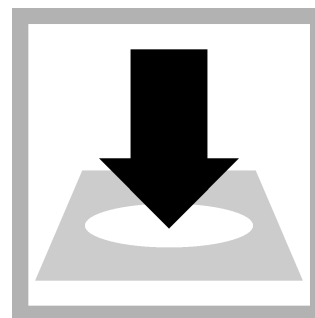

8. Insert the blank into the cell holder. Point the diamond mark on the sample cell toward the keypad.

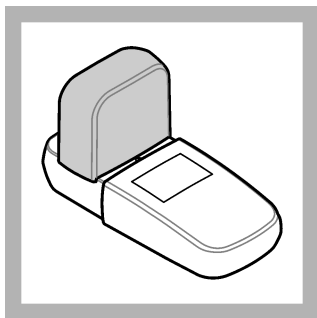

9. Install the instrument cap over the cell holder.

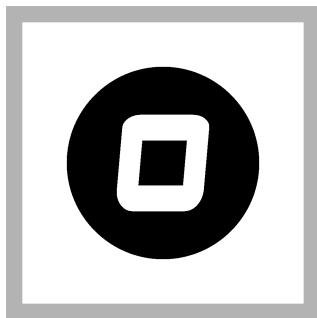

10. Push **ZERO**. The display shows "0.00".

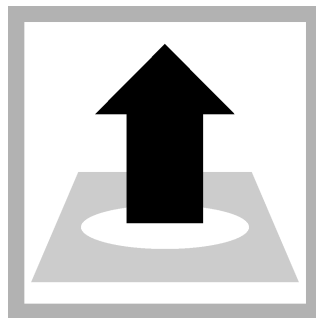

11. Remove the sample cell from the cell holder.

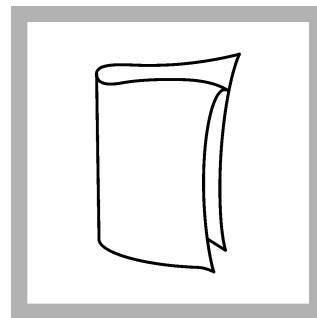

12. Clean the prepared sample cell.

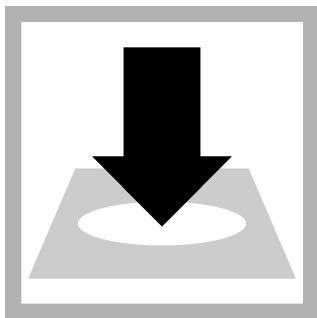

13. Within 10 minutes after the timer expires, insert the prepared sample into the cell holder. Point the diamond mark on the sample cell toward the keypad.

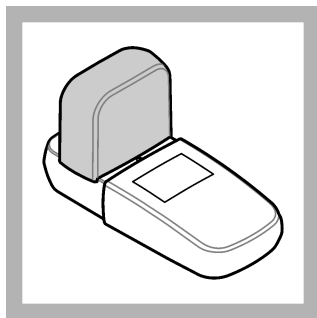

14. Install the instrument cap over the cell holder.

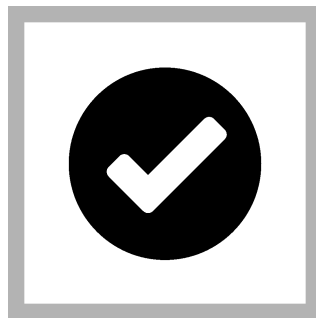

15. Push **READ**. Results show in mg/L phosphate (PO_4^{3-}). To change the test results to mg/L PO_2O_5 , multiply the test result by 0.747. To change the test results to mg/L P, multiply the test result by 0.326.

AccuVac[®] Ampul procedure

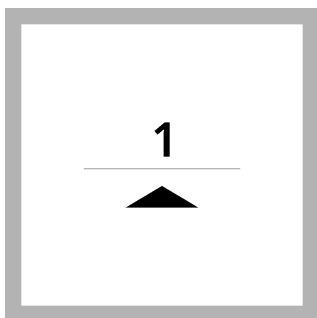

1. Set the instrument to channel 1.
For DR300, push the up arrow button. For PCII, push the menu button, checkmark button, then the menu button again.

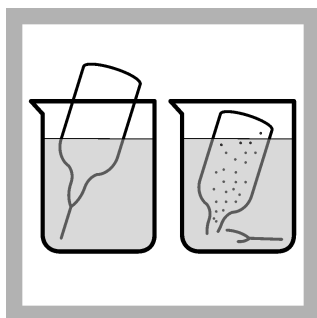

2. **Prepare the sample:** Collect at least 40 mL of sample in a 50-mL beaker. Fill the AccuVac Ampul with sample. Keep the tip immersed while the AccuVac Ampul fills completely.

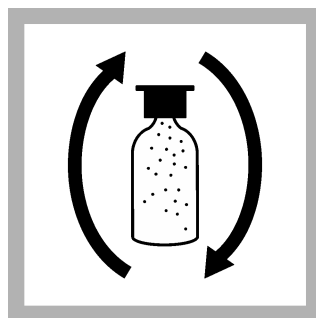

3. Quickly invert the AccuVac Ampul several times to mix.

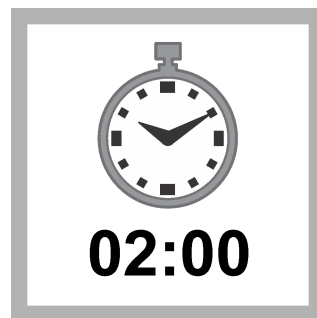

4. Set and start a timer for 2 minutes. A 2-minute reaction time starts.
If the sample was digested using the Acid Persulfate digestion procedure for Total Phosphorus, a 10-minute reaction period is necessary.

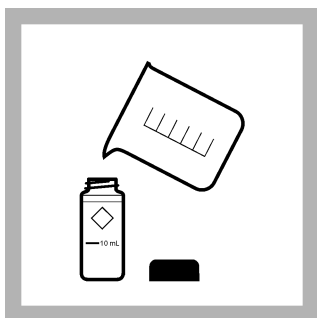

5. Prepare the blank:
Rinse a sample cell and cap three times with sample. Fill the sample cell to the 10-mL mark with sample. Close the sample cell.

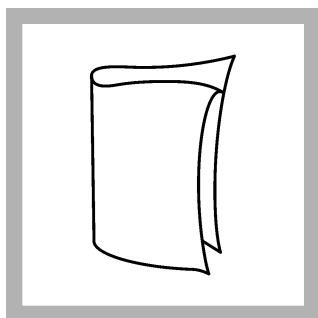

6. Clean the blank sample cell.

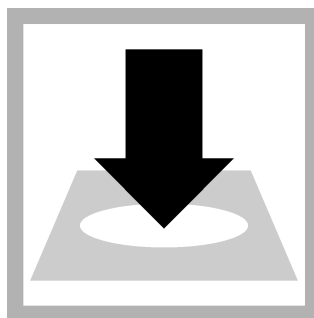

7. Insert the blank into the cell holder. Point the diamond mark on the sample cell toward the keypad.

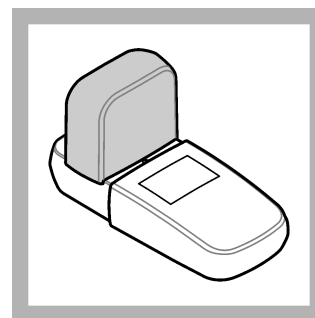

8. Install the instrument cap over the cell holder.

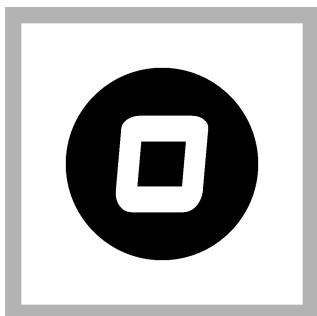

9. Push **ZERO**. The display shows "0.00".

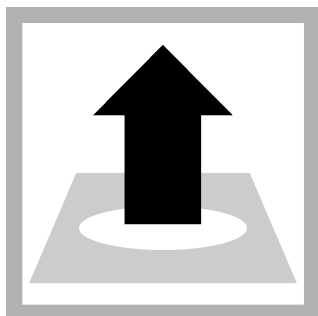

10. Remove the sample cell from the cell holder.

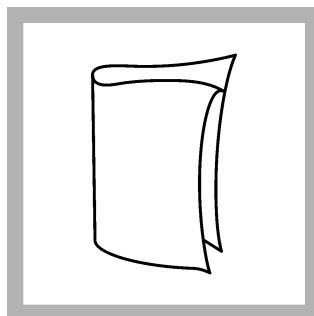

11. Clean the AccuVac Ampul.

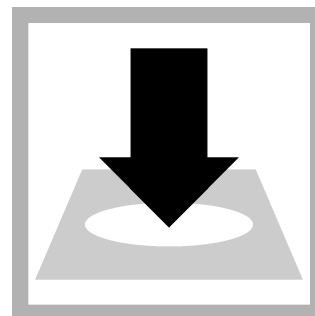

12. Within 10 minutes after the timer expires, insert the prepared sample AccuVac Ampul into the cell holder.

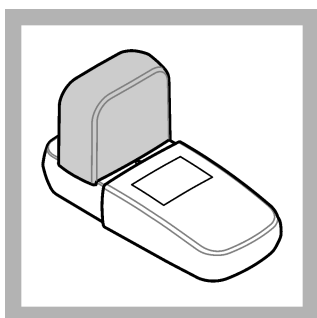

13. Install the instrument cap over the cell holder.



14. Push **READ**. Results show in mg/L phosphate (PO_4^{3-}). To change the test results to mg/L PO_2O_5 , multiply the test result by 0.747. To change the test results to mg/L P, multiply the test result by 0.326.

Interferences

Interfering substance	Interference level
Aluminum	More than 200 mg/L
Arsenate	Interferes at any level
Chromium	More than 100 mg/L

Interfering substance	Interference level
Copper	More than 10 mg/L
Hydrogen Sulfide	Interferes at any level
Iron	More than 100 mg/L
Nickel	More than 300 mg/L
Highly buffered samples or extreme sample pH	Can prevent the correct pH adjustment (of the sample) by the reagents. Sample pretreatment may be necessary. A pH range of 2–10 is recommended.
Silica	More than 50 mg/L
Silicate	More than 10 mg/L
Turbidity or color	Samples with a high amount of turbidity can give inconsistent results. The acid in the reagents can dissolve some of the suspended particles and variable desorption of orthophosphate from the particles can occur.
Zinc	More than 80 mg/L

Accuracy check

Standard additions method

Use the standard additions method to validate the test procedure, reagents and instrument and to find if there is an interference in the sample.

Items to collect:

- Phosphate Standard Solution, 50 mg/L PO_4^{3-} ampule
 - Ampule breaker
 - Pipet, TenSette®, 0.1–1.0 mL and tips
 - Mixing cylinders, 25-mL (3)
1. Prepare three spiked samples: use the TenSette pipet to add 0.1 mL, 0.2 mL and 0.3 mL of the standard solution, respectively, to three 25-mL portions of fresh sample. Mix well.
 2. Use the test procedure to measure the concentration of each of the spiked samples. Start with the smallest sample spike. Measure each of the spiked samples in the instrument.
 3. Compare the expected result to the actual result. The expected phosphate concentration increase is 0.2 mg/L for each 0.1 mL of standard that is added.

Standard solution method

Use the standard solution method to validate the test procedure, the reagents and the instrument.

Items to collect:

- 50 mg/L phosphate standard solution
 - 100-mL volumetric flask, Class A
 - 4-mL volumetric pipet, Class A and pipet filler safety bulb
 - Deionized water
1. Prepare a 2.00-mg/L phosphate standard solution as follows:
 - a. Use a pipet to add 4.00 mL of a 50-mg/L phosphate standard solution into the volumetric flask. (*Alternately, use one of the available mixed parameter standards. These standards contain 2.0 mg/L phosphate.*)
 - b. Dilute to the mark with deionized water. Mix well. Prepare this solution daily.
 2. Use the test procedure to measure the concentration of the prepared standard solution.

- Compare the expected result to the actual result.

Note: The factory calibration can be adjusted slightly with the standard calibration adjust option so that the instrument shows the expected value of the standard solution. The adjusted calibration is then used for all test results. This adjustment can increase the test accuracy when there are small variations in the reagents or instruments.

Method performance

The method performance data that follows was derived from laboratory tests that were measured on a DR300 and a Pocket Colorimeter II during ideal test conditions. Users can get different results under different test conditions.

Precision (95% confidence interval)
1.0 ± 0.04 mg/L PO ₄ ³⁻

Summary of method

Orthophosphate reacts with molybdate in an acid medium to produce a mixed phosphate/molybdate complex. Ascorbic acid then reduces the complex, which gives an intense molybdenum blue color.

Consumables and replacement items

Required reagents

Description	Quantity/Test	Unit	Item no.
PhosVer [®] 3 Phosphate Reagent Powder Pillow ¹ , 10 mL	1	100/pkg	2106069
OR			
PhosVer [®] 3 Phosphate Reagent AccuVac [®] Ampul	1	25/pkg	2508025

Required apparatus (powder pillows)

Description	Quantity/test	Unit	Item no.
Sample cells, 10-mL round, 25 mm x 60 mm	2	6/pkg	2427606

Required apparatus (AccuVac Ampul)

Description	Quantity/Test	Unit	Item no.
Sample cell, 10-mL round, 25 mm x 60 mm	1	6/pkg	2427606
Beaker, 50 mL	1	each	50041H
Stoppers for 18-mm tubes and AccuVac Ampuls	2	6/pkg	173106

Recommended standards and apparatus

Description	Unit	Item no.
Phosphate Standard Solution, 10-mL Voluette [®] Ampule, 50 mg/L as PO ₄	16/pkg	17110
Phosphate Standard Solution, 3-mg/L as PO ₄ ³⁻	946 mL	2059716
Drinking Water Standard, Mixed Parameter, Inorganic for F ⁻ , NO ₃ -N, PO ₄ ³⁻ , SO ₄ ²⁻	500 mL	2833049
Wastewater Effluent Standard Solution, Mixed Parameter, for NH ₃ -N, NO ₃ -N, PO ₄ ³⁻ , COD, SO ₄ ²⁻ , TOC	500 mL	2833249
Water, deionized	4 L	27256

¹ PhosVer is a registered trademark of Hach Company.

Optional reagents and apparatus

Description	Unit	Item no.
AccuVac [®] Drainer	each	4103600
AccuVac [®] Ampul Snapper	each	2405200
AccuVac [®] Ampul vials for sample blanks	25/pkg	2677925
Ampule Breaker, 10-mL Voluette [®] Ampules	each	2196800
Bottle, sampling, with cap, low density polyethylene, 250 mL	12/pkg	2087076
Mixing cylinder, graduated, 25 mL	each	189640
Hydrochloric Acid Solution, 6.0 N (1:1)	500 mL	88449
Paper, pH, 0–14 pH range	100/pkg	2601300
Phosphate Treatment Powder Pillows	100/pkg	1450199
Phosphate Standard Solution, 10 mg/L as PO ₄	946 mL	1420416
Phosphate Standard Solution, 500-mg/L as PO ₄	100 mL	1424232
Pipet, TenSette [®] , 0.1–1.0 mL	each	1970001
Pipet, TenSette [®] , 1.0–10.0 mL	each	1970010
Pipet tips for TenSette [®] Pipet, 0.1–1.0 mL	50/pkg	2185696
Pipet tips for TenSette [®] Pipet, 1.0–10.0 mL	50/pkg	2199796



Distribuidor autorizado de HACH en:

 Argentina

Tel: (+54 11) 5352 2500

Email: info@dastecsrl.com.ar

Web: www.dastecsrl.com.ar

 Uruguay www.dastecsrl.com.uy

 Paraguay www.dastecsrl.com.py



FOR TECHNICAL ASSISTANCE, PRICE INFORMATION AND ORDERING:
In the U.S.A. – Call toll-free 800-227-4224
Outside the U.S.A. – Contact the HACH office or distributor serving you.
On the Worldwide Web – www.hach.com; E-mail – techhelp@hach.com

HACH COMPANY
WORLD HEADQUARTERS
Telephone: (970) 669-3050
FAX: (970) 669-2932